

TECHNISCHE INFORMATIONEN

Balgen :	0.5 Faltenbalg
Breite :	23mm
Federweg :	3mm
Form :	Oval
Höhe :	22
Horizontalkraft :	60N
Kategorie :	Ovale
Länge :	63mm
Rohrinnendurchmesser :	AG G1/8"
Serie :	4RP
Sortiment :	Sauggreifer
Vertikalkraft :	30N

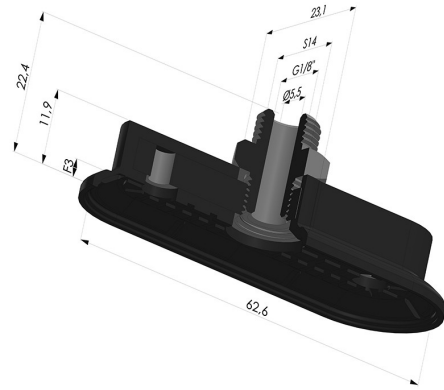

Varianten:



Variantenreferenz:

4RP 62NI M18

- Materiale: Nitril
- Shore-Härte: SH70